



Mini Hi-Fi System



Read this manual first!

Congratulations on purchasing this Philips product. We've included everything you need to get started. If you have any problems, Philips Representatives can help you get the most from your new product by explaining:

- Hookups,
- First Time Setup, and
- Feature Operation.

Do not attempt to return this product to the store.

For fast help, call us first!

1-800-531-0039

Thank you for making Philips a part of your home!



Let's make things better.



PHILIPS



Canada

English:

This digital apparatus does not exceed the Class B limits for radio noise emissions from digital apparatus as set out in the Radio Interference Regulations of the Canadian Department of Communications.

Français:

Cet appareil numérique n'émet pas de bruits radioélectriques dépassant les limites applicables aux appareils numériques de Class B prescrites dans le Règlement sur le Brouillage Radioélectrique édicté par le Ministère des Communications du Canada.

CAUTION

Use of controls or adjustments or performance of procedures other than herein may result in hazardous radiation exposure or other unsafe operation.

ATTENTION

L'utilisation des commandes ou réglages ou le non-respect des procédures ci-inclues peuvent se traduire par une exposition dangereuse à l'irradiation.

ATENCIÓN

El uso de mando o ajustes o la ejecución de métodos que no sean los aquí descritos puede ocasionar peligro de exposición a radiación.

This warning label is located on the rearside and inside this laser product.

CAUTION: INVISIBLE LASER RADIATION WHEN OPEN. DO NOT STARE INTO BEAM.
DANGER: INVISIBLE LASER RADIATION WHEN OPEN. AVOID DIRECT EXPOSURE TO BEAM.
VARO! AVATTAESSA JA SUOJALUKITUS OHITETTAESSA OLET ALTTIINANÄKYMÄTTÖMÄALLE LASERSATEILYLLE. ÄLÄ KATSO SATEESEEN.
WARNING! OSYNLIG LASERSTRÅLNING NÄR DENNA DEL ÄR ÖPPNAD. OCH SPÄRREN ÄR URKOPPLAD. BETRAKTA EJ STRÅLEN.

or

DANGER - Invisible laser radiation when open.
AVOID DIRECT EXPOSURE TO BEAM.

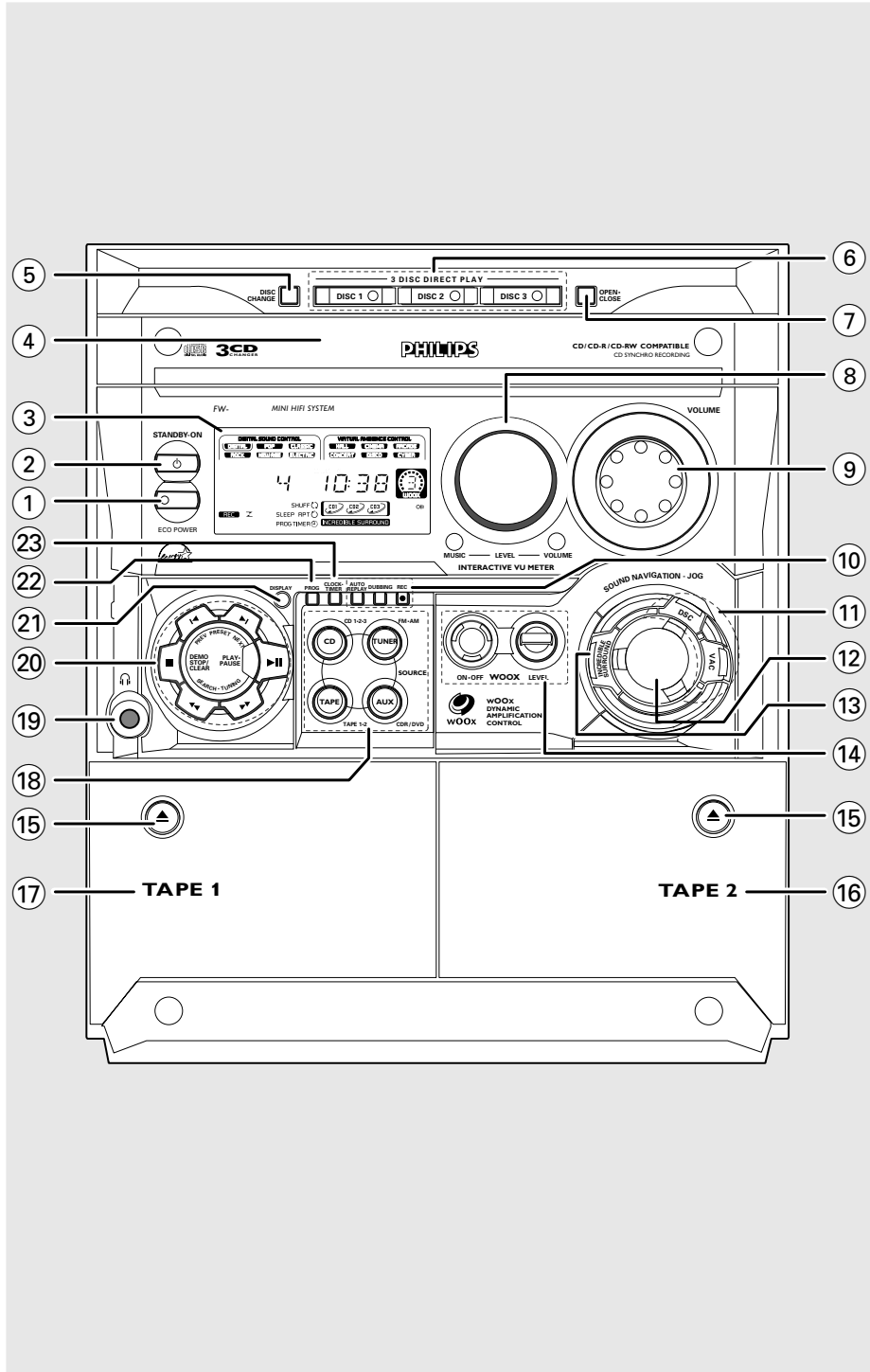

3



Return your Warranty Registration card today to ensure you receive all the benefits you're entitled to.

- Once your Philips purchase is registered, you're eligible to receive all the privileges of owning a Philips product.
- So complete and return the Warranty Registration Card enclosed with your purchase at once, and take advantage of these important benefits.

<p>Warranty Verification</p> <p>Registering your product within 10 days confirms your right to maximum protection under the terms and conditions of your Philips warranty.</p>	<p>Owner Confirmation</p> <p>Your completed Warranty Registration Card serves as verification of ownership in the event of product theft or loss.</p>	<p>Model Registration</p> <p>Returning your Warranty Registration Card right away guarantees you'll receive all the information and special offers which you qualify for as the owner of your model.</p>
---	--	---

Know these *safety symbols*



For Customer Use
Enter below the Serial No. which is located on the rear of the cabinet. Retain this information for future reference.

Model No. _____

Serial No. _____

 This "bolt of lightning" indicates uninsulated material within your unit may cause an electrical shock. For the safety of everyone in your household, please do not remove product covering.

 The "exclamation point" calls attention to features for which you should read the enclosed literature closely to prevent operating and maintenance problems.

WARNING: TO PREVENT FIRE OR SHOCK HAZARD, DO NOT EXPOSE THIS EQUIPMENT TO RAIN OR MOISTURE.

CAUTION: To prevent electric shock, match wide blade of plug to wide slot, and fully insert.



PHILIPS Visit our World Wide Web Site at <http://www.philips.com>

PHILIPS



***Congratulations on your purchase,
and welcome to the “family!”***

Dear Philips product owner:

Thank you for your confidence in Philips. You've selected one of the best-built, best-backed products available today. And we'll do everything in our power to keep you happy with your purchase for many years to come.

As a member of the Philips “family,” you're entitled to protection by one of the most comprehensive warranties and outstanding service networks in the industry.

What's more, your purchase guarantees you'll receive all the information and special offers for which you qualify, plus easy access to accessories from our convenient home shopping network.

And most importantly you can count on our uncompromising commitment to your total satisfaction.

All of this is our way of saying welcome – and thanks for investing in a Philips product.

Sincerely,

Lawrence J. Blanford
President and Chief Executive Officer

P.S. Remember, to get the most from your Philips product, you must return your Warranty Registration Card within 10 days. So please mail it to us right now!

5



IMPORTANT SAFETY INSTRUCTIONS

1. Read these instructions.
2. Keep these instructions.
3. Heed all warnings.
4. Follow all instructions.
5. Do not use this apparatus near water.
6. Clean only with a dry cloth.
7. Do not block any ventilation openings. Install in accordance with the manufacturer's instructions.
8. Do not install near any heat sources such as radiators, heat registers, stoves, or other apparatus (including amplifiers) that produce heat.
9. Do not defeat the safety purpose of the polarized or grounding-type plug. A polarized plug has two blades with one wider than the other. A grounding type plug has two blades and a third grounding prong. The wide blade or the third prong are provided for your safety. If the provided plug does not fit into your outlet, consult an electrician for replacement of the obsolete outlet.
10. Protect the power cord from being walked on or pinched, particularly at plugs, convenience receptacles, and the point where they exit from the apparatus.
11. Only use attachments/accessories specified by the manufacturer.

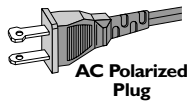

12.  Use only with the cart, stand, tripod, bracket, or table specified by the manufacturer or sold with the apparatus. When a cart is used, use caution when moving the cart/apparatus combination to avoid injury from tip-over.
13. Unplug this apparatus during lightning storms or when unused for long periods of time.
14. Refer all servicing to qualified service personnel. Servicing is required when the apparatus has been damaged in any way, such as power-supply cord or plug is damaged, liquid has been spilled or objects have fallen into the apparatus, the apparatus has been exposed to rain or moisture, does not operate normally, or has been dropped.
15. Battery usage **CAUTION** – To prevent battery leakage which may result in bodily injury or damage to the unit:
 - Install all batteries correctly, + and - as marked on the unit.
 - Do not mix batteries (old and new or carbon and alkaline, etc.).
 - Remove batteries when the unit will not be used for a long time.

EL 6475-E003: 01/6

Class II equipment symbol 
 This symbol indicates that the unit has a double insulation system



Index

English 8

Français 36

Español 65

English

Français



Español

DEMO MODE

To turn ON: Press & HOLD  button for 5 seconds

To turn OFF: Press & HOLD  button for 5 seconds

PLUG & PLAY

-  Plug in the unit
-  Follow instructions in the display
-  Press "PLAY"

MODE DE DEMONSTRATION

ACTIVER: Maintenez enfoncé le bouton  pendant 5 secondes

DÉSACTIVER: Maintenez enfoncé le bouton  pendant 5 secondes

PLUG & PLAY

-  Branchez le système
-  Suivez les instructions sur l'afficheur
-  Appuyez sur "PLAY"

MODO DE DEMOSTRACIÓN

ACTIVARLO: Mantenga apretado el botón  durante 5 segundos

DESACTIVARLO: Mantenga apretado el botón  durante 5 segundos

PLUG & PLAY

-  Conecte la unidad
-  Siga las instrucciones en la pantalla
-  Pulse "PLAY"



English

Contents

General Information

Environmental Information	9
Acknowledgement	9
Supplied Accessories	9
Safety Information	9

Preparations

Rear Connections	10–11
Optional Connections	12
Inserting batteries into the remote control	12

Controls

Controls on the system and remote control	13–14
---	-------

Basic Functions

Plug and Play	15
Demonstration mode	15
Switching the system on	16
Switching the system to Standby mode	16
Switching the system to Eco Power Standby mode	16
Power Saving Automatic Standby	16
Display mode	16
Volume Control	16
Sound Navigation	17

CD Operation

Discs for Playback	18
Loading Discs	18
Disc Playback	19
Programming the disc tracks	19–20
Repeat	20
Shuffle	20

Radio Reception

Storing Preset Radio Stations	21–22
Tuning to Preset Radio Stations	22
Erasing a Preset Radio Station	22

Tape Operation/Recording

Tape Playback	23–24
General Information on Recording	24
Preparation for Recording	25
One Touch Recording	25
CD Synchro Recording	25
Dubbing Tapes	25
Digital Recording via Digital Out	25

Clock/Timer

View Clock	26
Clock Setting	26
Timer Setting	26–27
Sleep Timer Setting	27

External Sources

Listening to External Sources	28
-------------------------------------	----

Maintenance

.....	28
-------	----

Specifications

.....	29
-------	----

Troubleshooting

.....	30–31
-------	-------



General Information

This system complies with the FCC rules, Part 15 and with 21 CFR 1040.10.

Operation is subject to the following two conditions:

- **This device may not cause harmful interference, and**
- **This device must accept any interference received, including interference that may cause undesired operation.**

Environmental Information

All unnecessary packaging has been omitted. We have tried to make the packaging easy to separate into three materials: cardboard (box), polystyrene foam (buffer) and polyethylene (bags, protective foam sheet).

Your system consists of materials which can be recycled and reused if disassembled by a specialized company. Please observe the local regulations regarding the disposal of packaging materials, exhausted batteries and old equipment.

Acknowledgement

Energy Star

As an ENERGY STAR® Partner, Philips has determined that this product meets the ENERGY STAR® guidelines for energy efficiency.



Supplied accessories

- Remote control
- Batteries (two AA size) for remote control
- AM loop antenna
- FM wire antenna
- AC power cord
- one cinch cable (GN/BU)
- Power booster amplifier package:
 - one power booster amplifier
 - one pair of speakers
 - AC power cord

Safety Information

- Before operating the system, check that the operating voltage indicated on the typeplate (or the voltage indication beside the voltage selector) of your system is identical with the voltage of your local power supply. If not, please consult your dealer.
- Place the system on a flat, hard and stable surface.
- Place the system in a location with adequate ventilation to prevent internal heat build-up in your system. Allow at least 10 cm (4 inches) clearance from the rear and the top of the unit and 5 cm (2 inches) from each side.
- Do not expose the system, batteries or discs to excessive moisture, rain, sand or heat sources caused by heating equipment or direct sunlight.
- If the system is brought directly from a cold to a warm location, or is placed in a very damp room, moisture may condense on the lens of the disc unit inside the system. Should this occur, the CD player would not operate normally. Leave the power on for about one hour with no disc in the system until normal playback is possible.
- The mechanical parts of the set contain self-lubricating bearings and must not be oiled or lubricated.
- **When the system is switched to Standby mode, it is still consuming some power. To disconnect the system from the power supply completely, remove the AC power plug from the wall socket.**



Preparations

English

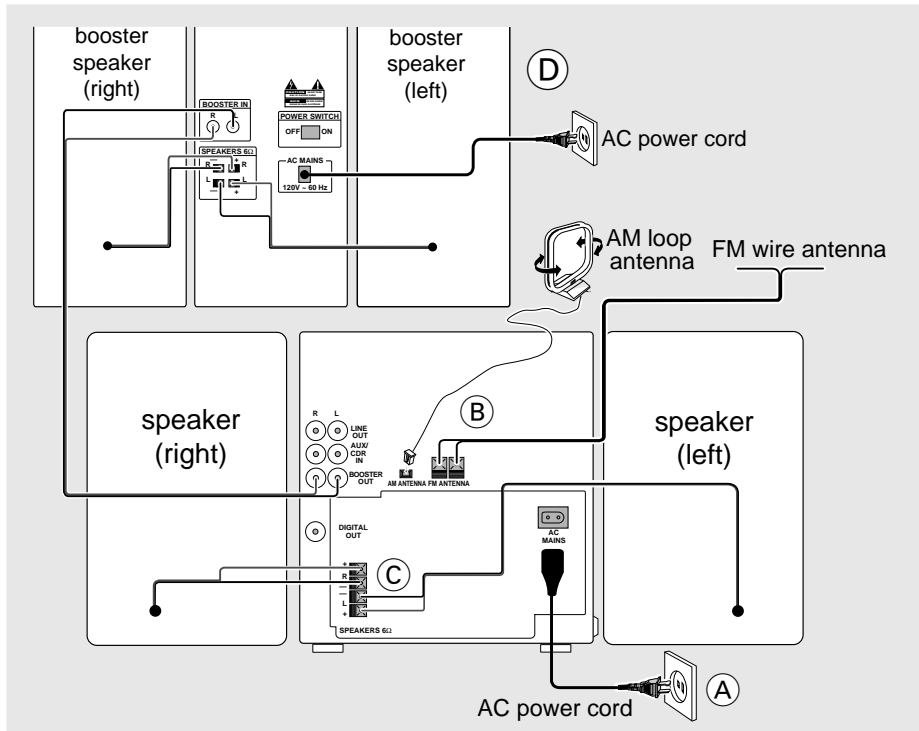

Rear Connections

The type plate is located at the rear of the system.

A Power

Before connecting the AC power cord to the wall outlet, ensure that all other connections have been made.

WARNING!

- For optimal performance, use only the original power cable.
- Never make or change connections with the power switched on.

To avoid overheating of the system, a safety circuit has been built in. Therefore, your system may switch to Standby mode automatically under extreme conditions. If this happens, let the system cool down before reusing it (not available for all versions).





Preparations

B Antennas Connection

Connect the supplied AM loop antenna and FM antenna to the respective terminals. Adjust the position of the antenna for optimal reception.

AM Antenna

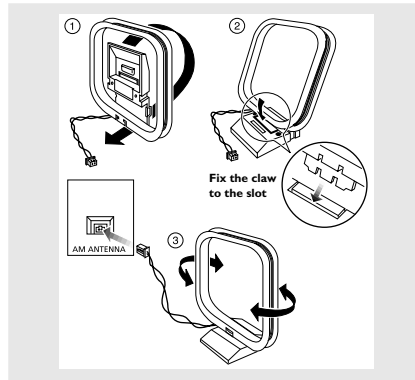

- Position the antenna as far as possible from a TV, VCR or other radiation source.

FM Antenna

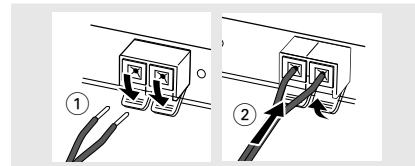

- For better FM stereo reception, connect an outdoor FM antenna to the FM ANTENNA terminal.

C Speakers Connection

Front Speakers

Connect the speaker wires to the SPEAKERS (FRONT) terminals, right speaker to "R" and left speaker to "L", colored (marked) wire to "+" and black (unmarked) wire to "-".

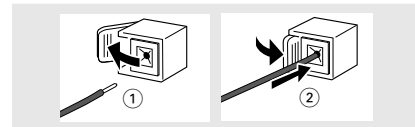

- Clip the stripped portion of the speaker wire as shown.

Notes:

- For optimal sound performance, use the supplied speakers.
- Do not connect more than one speaker to any one pair of + / - speaker terminals.
- Do not connect speakers with an impedance lower than the speakers supplied. Please refer to the SPECIFICATIONS section of this manual.

D Power Booster Connection

Refer to "Preparations - Rear Connections".

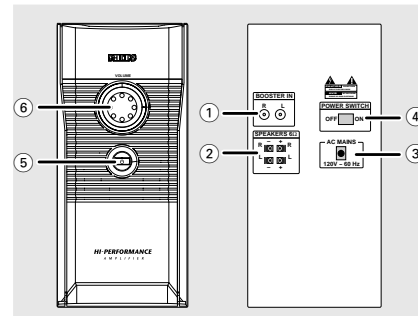

- 1 Connect the **BOOSTER OUT** (Right and Left) terminals of the mini system to the power booster amplifier **BOOSTER IN** (Right and Left) terminals respectively.
- 2 Connect the speaker wires to the **BOOSTER SPEAKERS** terminals, right speaker to "R" and left speaker to "L", colored (marked) wire to "+" and black (unmarked) wire to "-".
- 3 Plug in the AC mains to the wall socket.
- 4 Switch on the **POWER SWITCH** to activate the power booster amplifier.
- 5 Press **STANDBY ON** button to switch the system ON or to Standby mode.
- 6 Rotate the **VOLUME** control to adjust the loudness of the power booster amplifier.



Preparations

Optional Connections

The optional equipment and connecting cords are not supplied. Refer to the operating instructions of the connected equipment for details.

Line Out Connection

Connect this output to any analog audio equipment for playback or recording (CD recorder; tape recorder or amplifier for example). Use a cinch cable to connect the **LINE OUT** terminals to the analog audio in terminals of the equipment.

Connecting other equipment to your system

Connect the audio left and right OUT terminals of a TV, VCR, Laser Disc player, DVD player or CD Recorder to the **AUX/CDR IN** terminals.

Notes:

- Do not connect equipment to both the **LINE OUT** and **AUX/CDR IN** terminals at the same time. Otherwise, noise will be generated and malfunction might occur.
- If you are connecting equipment with a mono output (a single audio out terminal), connect it to the **AUX/CDR IN** left terminal. Alternatively, you can use a "single to double" cinch cable (still be mono sound).

Digital Out Connection

Connect this digital output when recording on any audio equipment with digital input (CD Recorder; Digital Audio Tape [DAT] deck, Digital to Analog Converter and Digital Signal Processor; for example). Use a cinch cable to connect the **DIGITAL OUT** terminal to the digital input terminal of the equipment.

Inserting batteries into the Remote Control

Insert two batteries (Type R06 or AA) into the remote control with the correct polarity as indicated by the **+** and **-** symbols inside the battery compartment.

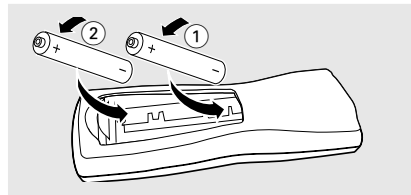

CAUTION!

- Remove batteries if they are exhausted or not to be used for a long time.
- Do not use old and new or different types of batteries in combination.
- Batteries contain chemical substances, so they should be disposed off properly.



Controls (main system's illustration on page 3)

Controls on the system and remote control

- ① **ECO POWER**
 - to switch the system on or to Eco Power Standby mode.
- ② **STANDBY ON**
 - to switch the system on or to Standby mode.
- ③ **DISPLAY SCREEN**
 - to view the current status of the system.
- ④ **DISC TRAY**
- ⑤ **DISC CHANGE**
 - to change disc(s).
- ⑥ **DISC 1 / DISC 2 / DISC 3 (CD DIRECT)**
 - to select a disc tray for playback.
- ⑦ **OPEN•CLOSE**
 - to open or close the disc tray.
- ⑧ **INTERACTIVE VU METER**
 - to show the VU (volume unit) meter in music or volume mode depending on the display mode selected.
- ⑨ **VOLUME**
 - to increase or decrease the volume.
- ⑩ **Tape Deck Operation**
 - AUTO REPLAY (AUTO RE.)**
 - to select continuous playback in either AUTO PLAY or ONCE mode only.
 - DUBBING**
 - to dub a tape.
 - REC**
 - to start recording on tape deck 2.
- ⑪ **SOUND NAVIGATION**
 - to select the desired sound feature : DSC or VAC.
- ⑫ **JOG CONTROL**
 - to select the desired sound effect for the selected sound feature.
- DSC DIGITAL, ROCK, POP, NEWAGE, CLASSIC or ELECTRIC.
- VAC HALL, CONCERT, CINEMA, DISCO, ARCADE or CYBER.
- ⑬ **INCREDIBLE SURROUND (IS)**
 - to activate or deactivate the surround sound effect.

- ⑭ **wOOx ON•OFF**
 - to select enhanced or normal wOOx sound effect.
- wOOx LEVEL**
 - to select desired wOOx level : WOOX 1, WOOX 2 or WOOX 3.
- ⑮ **▲**
 - to open the tape deck door.
- ⑯ **TAPE DECK 2**
- ⑰ **TAPE DECK 1**
- ⑱ **SOURCE** – to select the following:
 - CD / (CD 1•2•3)**
 - to select disc tray 1, 2 or 3.
 - TUNER / (FM•AM)**
 - to select waveband : FM or AM.
 - TAPE / (TAPE 1• 2)**
 - to select tape deck 1 or 2.
 - AUX / (CDR/DVD)**
 - to select a connected external source : CDR/DVD or AUX (auxiliary) mode.
- ⑲
 - to connect headphones.
- ⑳ **Mode Selection**
 - PLAY PAUSE ► II**
 - for CD to start or interrupt playback.
 - for TAPE to start playback.
 - for PLUG & PLAY... (on the system only) to initiate and start plug & play mode.
 - SEARCH•TUNING ◀◀ ▶▶**
 - for CD to search backward/forward.
 - for TUNER to tune to a lower or higher radio frequency.
 - for TAPE to rewind or fast forward.
 - for CLOCK (on the system only) to set the hour.





Controls

DEMO STOP/CLEAR ■

- for CD to stop playback or to clear a program.
- for TUNER to stop programming.
- (on the system only) to delete the preset radio station.
- for TAPE to stop playback or recording.
- to reset tape counter number.
- for DEMO (on the system only) to activate/deactivate the demonstration.
- for CLOCK (on the system only) to exit clock setting or cancel timer.
- for PLUG & PLAY... (on the system only) to exit plug & play mode.

PREV / PRESET / NEXT ◀ ▶

- for CD to skip to the beginning of the current, previous, or next track.
- for TUNER to select a preset radio station.
- for CLOCK (on the system only) to set the minute.

21 DISPLAY

- to select different screen display mode : NORMAL, MODE 1, MODE 2, or MODE 3.

22 PROG (PROGRAM)

- for CD to program disc tracks.
- for TUNER to program preset radio stations.
- for CLOCK (on the system only) to select 12- or 24-hour clock mode.

23 CLOCK-TIMER

- to view the clock, set the clock or set the timer.

24 MUTE

- to interrupt or resume sound reproduction.

25 CLOCK

- to view the clock display.

26 REPEAT

- to playback track(s)/disc(s)/program repeatedly.

27 SHUFFLE

- to playback all available discs and their tracks/program in random order.

28 TIMER ON/OFF

- to activate or deactivate the timer.

29 SLEEP

- to activate, deactivate or set the sleep timer.

30 ⏻

- to switch the system to Standby mode.
- to switch the system to Eco Power Standby mode.

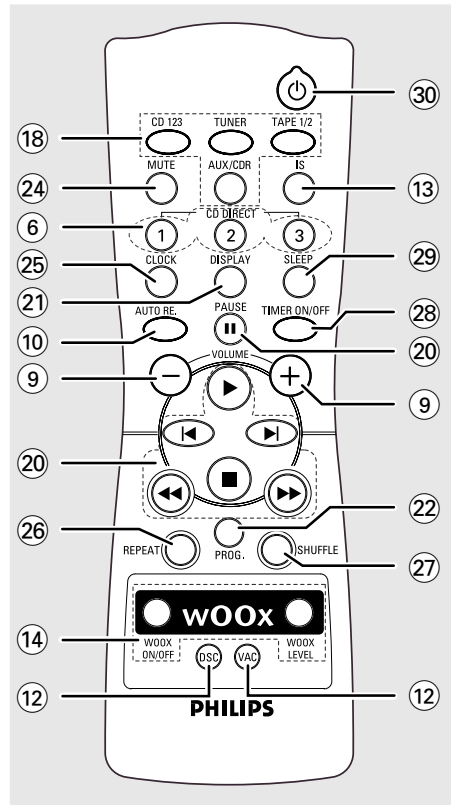

Notes for remote control:

- First, select the source you wish to control by pressing one of the source select keys on the remote control (CD 123 or TUNER, for example).
- Then select the desired function (▶, ◀, ▶|, for example).



Basic Functions

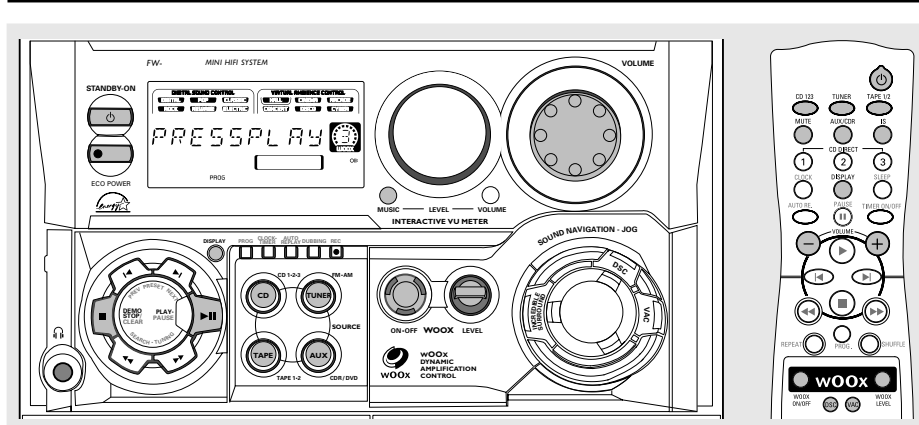

English

IMPORTANT!
Before you operate the system, complete the preparation procedures.

Plug and Play

Plug and Play allows you to store all available radio stations automatically.

If Plug and Play has not been installed

- 1 When you turn on the system, "AUTO INSTALL - PRESS PLAY" will be displayed.
- 2 Press **PLAY** on the system to start installation.
 - "INSTALL" will be displayed and followed by "TUNER" and then "AUTO".
 - **PROG** will start flashing.
 - The system will search for all radio stations on the FM band, then the AM band.
 - All available radio stations with sufficient signal strength will be stored automatically.
 - The system will stop searching when all the available radio stations are stored or when the memory for 40 preset radio stations is used.
 - The last preset radio station will play when Plug and Play is completed.

To reinstall Plug and Play

- 1 In Standby or Demonstration mode, press and hold **PLAY** on the system until "AUTO INSTALL - PRESS PLAY" is displayed.
- 2 Press **PLAY** again to start installation.
 - All previously stored radio stations will be replaced.

To exit without storing the Plug and Play

- Press **STOP** on the system.

Notes:

- When the power is turned on, the disc tray may open and close to initialize the system.
- If you do not complete Plug and Play installation, Plug and Play will be reinitiated the next time you turn on the power.
- If no stereo frequency is detected during Plug and Play, "CHECK ANTENNA" will be displayed.
- During Plug and Play, if no button is pressed within 15 seconds, the system will exit Plug and Play mode automatically.

Demonstration mode

The system has a demonstration mode that shows the various features offered by the system.

To activate the demonstration

- In Standby mode, press and hold **DEMO STOP** on the system until "DEMO ON" is displayed.
 - The demonstration will begin.

To deactivate the demonstration

- Press and hold **DEMO STOP** on the system until "DEMO OFF" is displayed.
 - The system will switch to Standby mode.

Note:

- Even if you remove the AC power cord and reconnect it to the wall socket, the demonstration will remain off until you activate it again.



Basic Functions

Switching the system on

In Standby/Demonstration mode

- Press **STANDBY ON**.
→ The system will switch to the last selected source.
- Press **CD, TUNER, TAPE, AUX** (or **CD 123, TUNER, TAPE 1/2** or **AUX/CDR** on the remote control).
→ The system will switch to the selected source.
- Press any one of the DISC DIRECT PLAY buttons.
→ The system will switch to CD mode.

In Eco Power Standby mode

- Press **ECO POWER**.
→ The system will switch to last selected source.
- Press **CD 123, TUNER, TAPE 1/2** or **AUX/CDR** on the remote control.
→ The system will switch to the selected source.

Switching the system to Standby mode

In Demonstration mode

- Press and hold **DEMO STOP** ■ on the system.

In any other source mode (except Eco Power Standby mode)

- Press **STANDBY ON** (or  on the remote control).
→ The clock will appear on the display when the system is in Standby mode.

Switching the system to Eco Power Standby mode (< 1 Watt)

- Press **ECO POWER** (or press and hold  on the remote control).
→ "ECO POWER" will be displayed, then the display screen will go blank.
→ The low power ECO POWER LED will be lighted.

Note:

– If you have not deactivated the demonstration, it will resume five seconds after the system switches to Eco Power Standby or Standby mode.

Power Saving Automatic Standby

As a power-saving feature, the system will automatically switch to Standby mode if you do not press any buttons within 30 minutes after a disc or tape has stopped playing.

Display mode

There are four different display modes for selection.

- Press **DISPLAY** repeatedly to select NORMAL, MODE 1, MODE 2, or MODE 3.

NORMAL All available LEDs will light up and the display screen will have full brightness. The VU meter will be in music mode.

MODE 1 All available LEDs will light up and the display screen will have full brightness. The VU meter will be in volume mode.

MODE 2 All available LEDs will light up and the display screen will be at half brightness. The VU meter will be in music mode.

MODE 3 The display screen will be at half brightness. The VU meter and all LEDs will be off.

Volume Control

Adjust **VOLUME** to increase (turn knob clockwise or press **VOLUME +**) or decrease (turn knob counter-clockwise or press **VOLUME -**) the sound level.

To listen through the headphones

- Connect the headphones plug to the  socket at the front of the system.
→ The speakers will be muted.

To switch off the volume temporarily

- Press **MUTE** on the remote control.
→ Playback will continue without sound and "MUTE" will be displayed.
- To restore the volume, press **MUTE** again or increase the VOLUME level.



Basic Functions

Sound Navigation

For optimal sound listening, select only one of the following navigation sound controls at a time : wOOx, DSC or VAC.

wOOx

There are three wOOx settings to enhance the bass response.

- 1 Press **wOOx ON•OFF** to switch ON (enhanced) or OFF (normal) the wOOx sound effect.
 - When wOOx is switched on;
 - **wOOx** and the last selected wOOx level will appear on the display.
 - When wOOx is switched off;
 - The display will show "wOOx: NORM" and **wOOx** will disappear from the display.
- 2 When wOOx is switched on, adjust **wOOx LEVEL** (or press **wOOx LEVEL** on the remote control) to select the desired wOOx level: WOOX 1, WOOX 2 or WOOX 3.



Note:

– Some discs or tapes might be recorded in high modulation, which causes a distortion at high volume. If this occurs, deactivate wOOx or reduce the volume.

DSC (Digital Sound Control)

The DSC feature enables you to adjust the system to suit your type of music.

- 1 Press **DSC**.
 - DSC button lights up
- 2 Adjust the **JOG CONTROL** (or press **DSC** on the remote control repeatedly) to select the desired Digital Sound Control effect : DIGITAL, ROCK, POP, NEWAGE, CLASSIC or ELECTRIC.
 - The selected DSC will be highlighted.

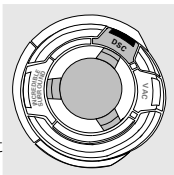

Note:

– For a neutral sound effect, select CLASSIC.

VAC (Virtual Ambience Control)

The VAC feature enables you to adjust the system to select a type of environment.

- 1 Press **VAC**.
 - VAC button lights up.
- 2 Adjust the **JOG CONTROL** (or press **VAC** on the remote control repeatedly) to select the desired Virtual Ambience Control effect : HALL, CONCERT, CINEMA, DISCO, ARCADE or CYBER.
 - The selected VAC will be highlighted.

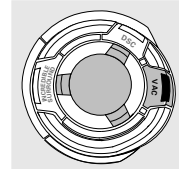

Note:

– When you select VAC, Incredible Surround will switch on automatically.

Automatic DSC-wOOx / VAC-wOOx selection

The best wOOx setting is generated automatically for each DSC or VAC selection. You can manually select the wOOx setting that best suits your listening environment.

Incredible Surround

The Incredible Surround magnifies the virtual distance between the front speakers for an incredibly wide, enveloping, stereo effect.

- Press **INCREDIBLE SURROUND** (or **IS** on the remote control) repeatedly to activate/deactivate the surround sound effect.
 - If activated, **INCREDIBLE SURROUND** will appear on the display and the INCREDIBLE SURROUND button lights up.
 - If deactivated, "IS OFF" will be displayed.

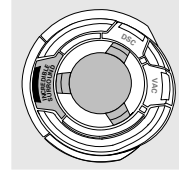



CD Operation

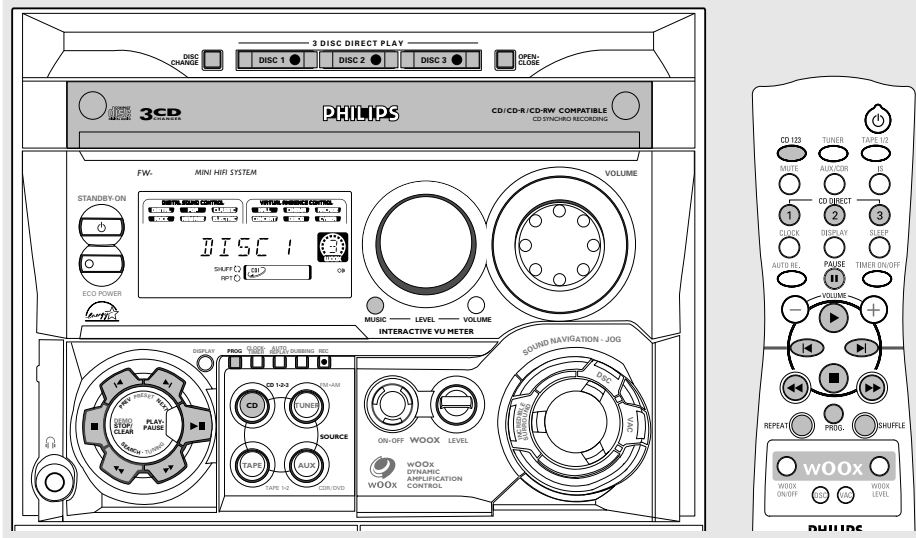

IMPORTANT!

- This system is designed for regular discs. Therefore, do not use any accessories such as disc stabilizer rings or disc treatment sheets, etc., as offered on the market, because they may jam the changer mechanism.
- Do not load more than one disc into each tray.

Discs for Playback

This system can playback all digital audio CD, finalized digital audio CD-Recordable (CDR) discs and finalized digital audio CD-Rewritable (CDRW) discs.



Loading Discs

- 1 Press **CD** to select CD mode.
- 2 Press **OPEN•CLOSE** to open the disc tray.
- 3 Load up to two discs on the individual disc trays.
To load the third disc, press **DISC CHANGE**.
→ The disc tray will rotate until the empty tray is ready for loading.

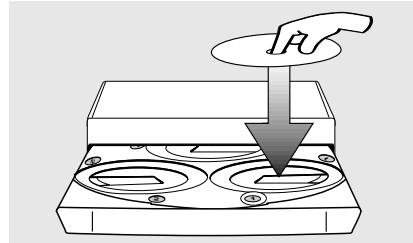

- 4 Press **OPEN•CLOSE** to close the disc tray.
→ "READING" will be displayed. The selected disc tray, total number of tracks and the playing time will appear on the display.
→ A lighted button indicates that a disc is loaded in the disc tray.

Notes:

- Load the discs with the label side facing up.
- To ensure good system performance, wait until the disc tray completely reads the disc(s) before proceeding.



CD Operation

Disc Playback

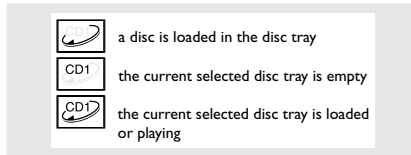

To playback all discs on the disc tray

- Press **PLAY ▶**.
 - All the available discs will playback once, then stop.
 - During playback, the selected disc tray, track number and elapsed playing time of the current track will appear on the display.

To playback one disc only

- Press the DISC DIRECT PLAY button : **DISC 1**, **DISC 2** or **DISC 3**.
 - The selected disc will playback once, then stop.

To interrupt playback

- Press **PAUSE II**
- To resume playback, press **PLAY ▶** again.

To stop playback

- Press **■**.

To search for a particular passage during playback

- Press and hold **◀◀** or **▶▶** and release it when the desired passage is located.
 - During searching, the volume will be reduced.

To select a desired track

- Press **◀** or **▶** repeatedly until the desired track appears on the display.
- If playback is stopped, press **PLAY ▶** to start playback.

Note:

- In Shuffle mode, pressing **◀** will cause the player to skip only to the beginning of the current track.

To skip to the beginning of the current track during playback

- Press **◀ once**.

Replace discs during playback

- 1 Press **DISC CHANGE**.
- 2 To change the inner disc, press **DISC CHANGE** again.
 - "DISC CHANGE" will be displayed and the disc will stop playing.
 - The disc tray will close to retrieve the inner disc, then reopen with the inner disc accessible.

Programming the disc tracks

Programming tracks is possible when playback is stopped. Up to 40 tracks can be stored in the memory in any order.

- 1 Load the desired discs on the disc tray (refer to "Loading Discs").
 - 2 Press **PROG** to start programming.
 - **PROG** will start flashing.
 - 3 Press **CD** (CD 1•2•3) or **DISC 1/2/3** button to select a disc.
 - 4 Press **◀** or **▶** repeatedly to select the desired track.
 - 5 Press **PROG** to store the track.
 - Repeat **steps 3–5** to store other discs and tracks.
 - 6 Press **PLAY ▶** to start program playback.
 - "PLAY PROGRAM" will be displayed.
- To end programming without starting playback, press **■ once**.
 - The total number of tracks programmed and the total playing time will appear on the display.

Notes:

- If the total playing time is more than "99:59" or if one of the programmed tracks has a number greater than 30, then "- : -" will appear on the display instead of the total playing time.
- If you attempt to program more than 40 tracks, "PROGRAM FULL" will be displayed.
- If you press any of the DISC DIRECT PLAY buttons, the system will playback the selected disc or track, and the stored program will be ignored temporarily. The **PROG** symbol also will disappear temporarily from the display. It will reappear when playback of the selected disc ends.
- During programming, if no button is pressed within 20 seconds, the system will exit the Program mode automatically.



CD Operation

To review the program

- Stop playback and press ◀ or ▶ repeatedly.
- To exit review mode, press ■.

To erase the entire program

- Press ■ **once** when playback is stopped or **twice** during playback.
 - "PROGRAM CLEAR" will be displayed.
 - **PROG** will disappear from the display.

Note:

– The program will be erased when the system is disconnected from the power supply or when the disc tray is opened.

Repeat

The current track, a disc, all available discs or all programmed tracks can be played repeatedly.

- 1 Press **REPEAT** on the remote control repeatedly to select various repeat modes.
 - **In normal playback**
 - "TRACK" – to repeat the current track.
 - "DISC" – to repeat the entire disc.
 - "ALL DISC" – to repeat all available discs.
 - **RPT** ⏪ appears on the display.
 - **In program playback**
 - "TRACK" – to repeat the current programmed track.
 - "PROGRAM" – to repeat all programmed tracks.
 - **RPT** ⏪ and **PROG** will appear on the display.
 - The selected track/disc(s)/program will now be played repeatedly until you press ■.
- 2 To resume normal playback, press **REPEAT** until the "OFF" mode is displayed.
 - **RPT** ⏪ will disappear from the display.

Note:

– Selecting **SHUFFLE** during repeat playback will cancel all repeat modes.

Shuffle

All the available discs and their tracks or all the programmed tracks can be played in random order:

- 1 Press **SHUFFLE** on the remote control.
 - "SHUFFLE" and **SHUFF** ⏪ will appear on the display.
 - The discs and the tracks will be played in random order until you press ■.
- 2 To resume normal playback, press **SHUFFLE** again.
 - **SHUFF** ⏪ will disappear from the display.

When select REPEAT mode during shuffling

- **In normal shuffled playback**
 - "TRACK" and "ALL DISC" repeat modes are available for selection.
 - **RPT** ⏪ and **SHUFF** ⏪ will appear on the display.
- **In program shuffled playback**
 - "TRACK" or "PROGRAM" repeat modes are available for selection.
 - **RPT** ⏪, **SHUFF** ⏪ and **PROG** will appear on the display.

For Recording, please refer to "Tape Operation/Recording".



Radio Reception

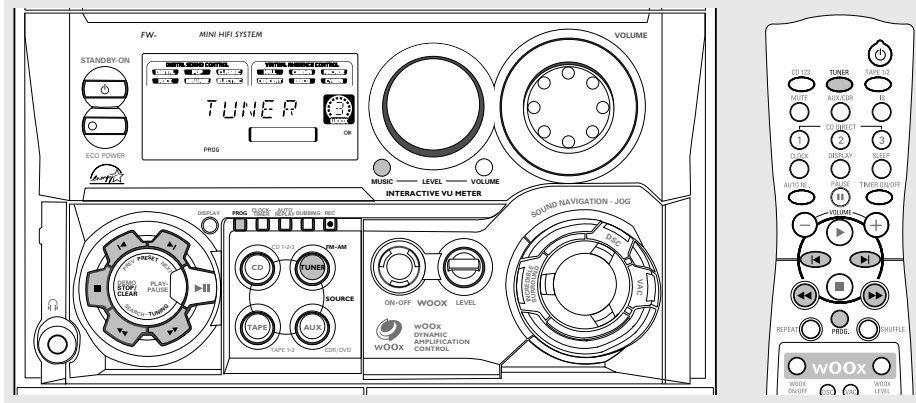

English

Storing Preset Radio Stations

You can store up to 40 preset radio stations in the memory.

Automatic Preset Programming

- Plug and Play setting (refer to "Basic Functions - Plug and Play").

OR

- 1 Press **TUNER** (FM•AM) to select TUNER mode.
 - "TUNER" will be displayed. A few seconds later, the current radio frequency will appear on the display.
 - If a FM station is received in stereo, ∞ will appear on the display.

To begin automatic preset from a desired preset number

- Press **◀** or **▶** to select the desired preset number.
 - For those radio stations that had been stored in one of the preset will not be restored again to another preset number.

- 2 Press and hold **PROG** until "AUTO" appears on the display.

- **PROG** will start flashing.
- The system will start searching for all radio stations on the FM band and then the AM band.
- All available radio stations with sufficient signal strength will be stored automatically.
- The system will stop searching when all the available radio stations are stored or when the memory for 40 preset radio stations is used.
- The last preset radio station will then be played when completed.

To stop storing the automatic preset

- Press **PROG** or **■** on the system.

Note:

- If no preset number is selected, automatic preset will begin from preset (1) and all your former presets will be overridden.



Radio Reception

Manual Preset Programming

- 1 Press **TUNER** (FM•AM) repeatedly to select the desired waveband : FM or AM.
- 2 Press **PROG**.
 - **PROG** will start flashing.
 - The next available preset number will be displayed for selection.
- 3 Press and hold **◀** or **▶** until the frequency indication starts to change, then release.
 - The display will show "SEARCH" until a radio station with sufficient signal strength is found.

To store the radio station to another preset number

- Press **◀** or **▶** to select the desired preset number.
- 4 Press **PROG** again to store the radio station.
 - **PROG** will disappear from the display.
- Repeat **steps 2–4** to store other preset radio stations.

Tuning to a weak radio station

- Press **◀** or **▶** briefly and repeatedly until the optimal reception is found.

To stop storing the manual preset

- Press **■** on the system.

Notes:

- If you attempt to store more than 40 preset radio stations, "PROGRAM FULL" will be displayed.
- During programming, if no button is pressed within 20 seconds, the system will exit the Program mode automatically.

Tuning to Preset Radio Stations

- Once you've preset the radio stations, press **◀** or **▶** to select the desired preset number.
 - The preset number, radio frequency, and waveband will appear on the display.

Erasing a Preset Radio Station

- 1 Press **◀** or **▶** to select the preset radio station to be erased.
- 2 Press and hold **■** on the system until "PRESET DELETE" appears on the display.
 - The radio frequency remain on the display.
 - The preset numbers of all other preset radio stations in the band with higher numbers are also decreased by one.
- Repeat **steps 1–2** to erase other preset radio stations.

For Recording, please refer to "Tape Operation/Recording".



Tape Operation/Recording

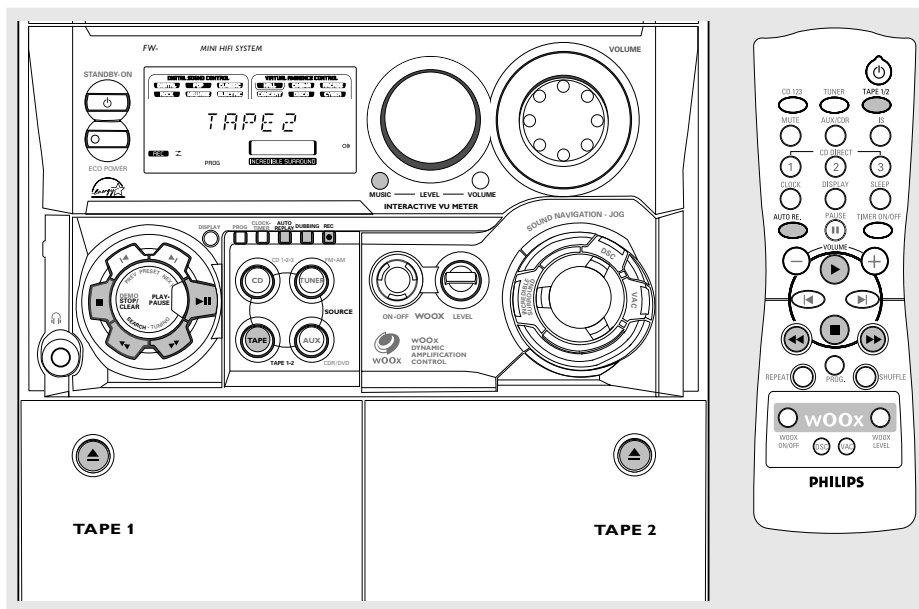

English

IMPORTANT!

- Before playing a tape, check and tighten slack tape with a pencil. Slack tape may get jammed or may burst in the mechanism.
- C-120 tape is extremely thin and is easily deformed or damaged. It is not recommended for use in this system.
- Store the tapes at room temperature and do not put them too close to a magnetic field (for example, a transformer, TV or speaker).

Tape Playback

- 1 Press **▲** to open the tape deck door.
- 2 Insert a recorded tape and close the tape door.
- Load the tape with the open side down and the full spool to the left.

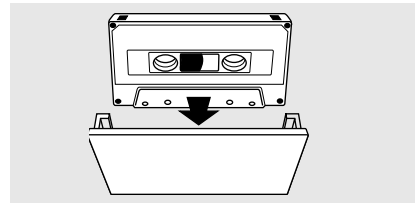

- 3 Press **TAPE** (TAPE 1•2) repeatedly to select tape deck 1 or tape deck 2.
→ The selected tape deck number is displayed.
- 4 Press **PLAY** **▶** to start playback.

To stop playback

- Press **■**.



Tape Operation/Recording

To change the playback mode

- Press **AUTO REPLAY** repeatedly to select the different playback modes.
→ "AUTO REPLAY" (⏮) or "ONCE" will appear on the display.

AUTO REPLAY ...the tape will rewind automatically at the end of playback and replay again. It will replay up to a maximum of 20 times until you press ■.

ONCEthe tape will playback the selected side once and then stop.

To rewind or fast forward when playback is stopped

- 1 Press ◀ or ▶.
- 2 Press ■ when you reached the desired passage.

To reset tape counter number

- When in stop mode, press ■.
→ "T 1 000" or "T2 000" will be displayed.

Notes:

- During rewinding or fast forwarding of a tape, it is also possible to select another source (CD, TUNER or AUX, for example).
- The tape counter will automatically set to zero after detecting end of tape.

General Information on Recording

- For recording, use only tape of IEC type I (normal tape).
- The recording level is set automatically, regardless of the position of the Volume, VAC, DSC and so forth.
- The tape is secured at both ends with leader tape. At the beginning and end of the tape, nothing will be recorded for six to seven seconds.
- To prevent accidental recording, break out the tab on the left shoulder of the tape side you want to protect.

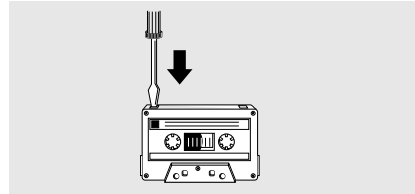

- If "CHECK TAPE" is displayed, the protection tab has been broken. Put a piece of clear adhesive tape over the opening.

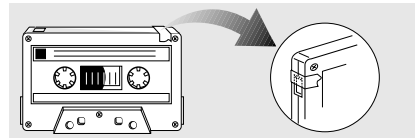



Tape Operation/Recording

IMPORTANT!

- Recording is permissible if copyright or other rights of third parties are not infringed upon.
- Recording is possible only on tape deck 2.

Preparation for Recording

- 1 Press **TAPE** (TAPE 1•2) to select TAPE 2.
- 2 Load a recordable tape into tape deck 2 with full spool to the left.
- 3 Prepare the source to be recorded.
 - CD** – load the disc(s).
 - TUNER** – tune to the desired radio station.
 - TAPE** – load the prerecorded tape into tape deck 1 with the full spool to the left.
 - AUX** – connect external equipment.

When recording is in progress

- **REC** starts flashing.
- It is not possible to listen to another source except for dubbing tapes.
- It is not possible to activate the timer function.

One Touch Recording

- 1 Press **CD**, **TUNER** or **AUX** to select the source.
- 2 Start playback of the selected source.
- 3 Press **REC** to start recording.

To stop recording

- Press **■** on the system.

Note:

- One Touch Recording is not possible in TAPE mode, "SELECT SOURCE" will be displayed.

CD Synchro Recording

- 1 Press **CD 1•2•3** to select the disc.
 - Press **◀** or **▶** to select the desired track to start recording.
 - You can program the tracks in the order you want them to be recorded (refer to "CD Operation - Programming the disc tracks").
- 2 Press **REC** to start recording.
 - The disc will start playback automatically.

To select another track during recording

- 1 Press **PAUSE II** to interrupt recording.
- 2 Press **◀** or **▶** to select the desired track.
- 3 Press **PLAY ▶** to resume recording.

To stop recording

- Press **■**.
 - Recording and disc playback will stop simultaneously.

Dubbing Tapes

- 1 Load the prerecorded tape in tape deck 1.
 - You can set the tape to the desired passage where recording will start.
- 2 Press **DUBBING**.
 - Playing and recording will start simultaneously.
 - "DUB DDD" will be displayed.
 - Dubbing of tapes is possible on one side of the tape only. To continue record on the reverse side, at the end of side A, flip the tapes to side B and repeat the procedure.

To stop dubbing

- Press **■**.

Notes:

- Dubbing of tapes is possible only from tape deck 1 to tape deck 2.
- To ensure good dubbing, use tapes of the same length.
- You can listen to another source while dubbing.

Digital Recording via Digital Out

For CD digital recording, please refer to the instruction manuals for the CD recorder, digital audio equipment and so forth.





Clock/Timer

English

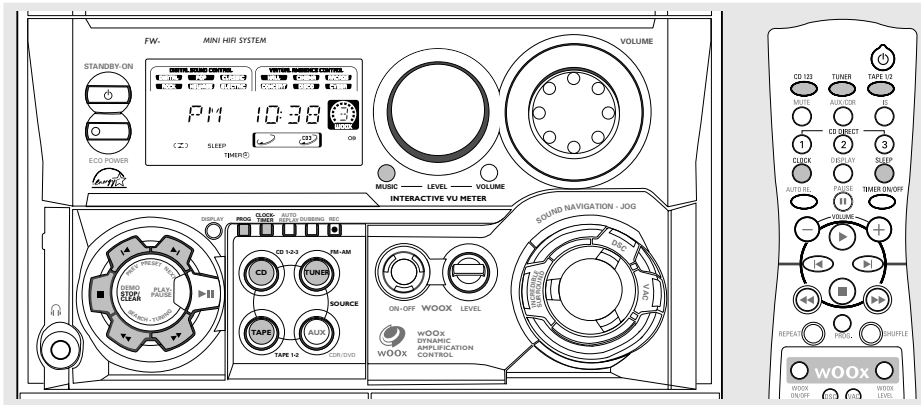

IMPORTANT!

– When in Eco Power Standby mode, it is not possible to operate clock or timer function.

View Clock

The clock (if it is set) will be shown in Standby mode.

To view the clock in any source mode (CD or TUNER for example)

- Press **CLOCK•TIMER** (or **CLOCK** on the remote control).
 - The clock will be displayed for a few seconds.
 - If the clock has not been set, "--:--:--" will be displayed.

Clock Setting

The clock can be set in either 12-hour or 24-hour mode ("PM 12:00" or "00:00" for example)

- 1 Press **CLOCK•TIMER** twice.
- 2 Press **PROG** on the system repeatedly to select clock mode.
 - If 12-hour mode is selected, "PM 12:00" will start flashing.
 - If 24-hour mode is selected, "00:00" will start flashing.
- 3 Press **◀** or **▶** on the system repeatedly to set the hour.
- 4 Press **◀** or **▶** on the system repeatedly to set the minute.

- 5 Press **CLOCK•TIMER** again to store the setting.
 - The clock will start working.

To exit without storing the setting

- Press **■** on the system.

Notes:

- The clock setting will be cancelled when the power cord is disconnected or if a power failure occurs.
- During clock setting, if no button is pressed within 90 seconds, the system will exit clock setting mode automatically.

Timer Setting



The system can switch on to CD, TUNER, or TAPE 2 mode automatically at a preset time, serving as an alarm to wake you up.

IMPORTANT!

- Before setting the timer, ensure that the clock is set correctly.
- The timer will always be switched on after it has been set.
- The timer will not start if a recording is in progress.
- The volume of the timer will increase gradually from the minimum level until it reaches the last tuned volume level.



Clock/Timer

- 1 Press and hold **CLOCK•TIMER** for more than **two seconds** to select timer mode.
 - "FM 12:00" or "00:00" or the last timer setting will start flashing.
 - **TIMER**  will start flashing.
 - The selected source will be lighted while other available sources are flashing.
 - 2 Press **CD, TUNER** or **TAPE** to select the desired source.
 - Before setting timer, make sure the music source has been prepared.
 - CD** – Load the disc(s). To start from a specific track, make a program (refer to "CD Operation - Programming the disc tracks").
 - TUNER** – tune to the desired radio station.
 - TAPE** – load the prerecorded tape into tape deck 2.
 - 3 Press **◀** or **▶** on the system repeatedly to set the hour for the timer to start.
 - 4 Press **⏪** or **⏩** on the system repeatedly to set the minute for the timer to start.
 - 5 Press **CLOCK•TIMER** to store the start time.
 - "TIMER ON" will be displayed and followed by the set timer "XX:XX" and then the selected source.
 - **TIMER**  will remain on the display.
 - At the preset time, the selected source will play.
- To exit without storing the setting**
- Press **■** on the system.

Notes:

- If the selected source (CD) is not available when preset timer is reached, TUNER will be selected automatically.
- During timer setting, if no button is pressed within 90 seconds, the system will exit timer setting mode automatically.

To deactivate the TIMER

- Press **TIMER ON/OFF** on the remote control.
 - The display will show "CANCEL" and **TIMER**  will disappear from the display.

To activate the TIMER

- Press **TIMER ON/OFF** on the remote control.
 - The last set timer information will be shown for a few seconds and **TIMER**  will appear on the display.

Sleep Timer Setting

The sleep timer enables the system to switch to Standby mode automatically at a preset time.

- 1 Press **SLEEP** on the remote control repeatedly to select a preset time.
 - The selections are as follows (time in minutes):
 - 15 → 30 → 45 → 60 → OFF → 15 ...
 - "SLEEP XX" or "OFF" will be displayed. "XX" is the time in minutes.
- 2 When you reach the desired length of time, stop pressing the **SLEEP** button.
 - **SLEEP** will appear on the display, except for "OFF" mode.
 - The Sleep Timer is now set. Before the system switches to standby mode, a countdown of 10 seconds will be displayed.
 - "SLEEP 10" → "SLEEP 9" ... → "SLEEP 1"
 - "SLEEP"

While SLEEP mode is activated

To check the remaining length of time

- Press **SLEEP once**.

To change the preset sleep timer

- Press **SLEEP twice**.
 - The display will show the remaining time followed by the sequence of sleep timer options.

To deactivate the Sleep Timer

- Press **SLEEP** repeatedly until "OFF" is displayed, or press the **STANDBY ON** button.



External Sources

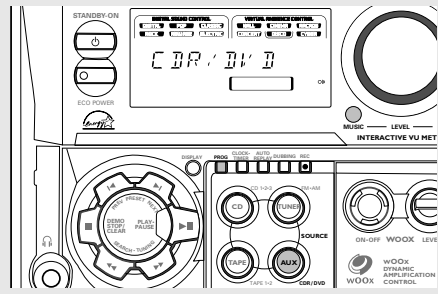

- When CDR/DVD mode is selected, any audio equipment connected to the LINE OUT terminals of this mini system will be muted. You will not be able to record or listen to the sound from the LINE OUT source.
- If the sound from the external source is distorted, select CDR/DVD mode for listening.

Notes:

- You are advised not to listen to and record from the same source simultaneously.
- All the navigation sound control features (DSC or VAC for example) are available for selection.
- Refer to the operating instructions for the connected equipment for details.

Listening to External Sources

- 1 Connect the audio out terminals of the external equipment (TV, VCR, Laser Disc player, DVD player or CD Recorder) to the AUX/CDR IN terminals of your system.
- 2 Press **AUX** (CDR/DVD) repeatedly to select CDR/DVD mode or normal AUX mode.
→ "CDR/DVD" or "AUX" will be displayed.

For Recording, please refer to "Tape Operation/Recording".

Maintenance

Cleaning the Cabinet

- Use a soft cloth slightly moistened with a mild detergent solution. Do not use a solution containing alcohol, spirits, ammonia or abrasives.

Cleaning Discs

- When a disc becomes dirty, clean it with a cleaning cloth. Wipe the disc from the center out. Do not wipe in a circular motion.
- Do not use solvents such as benzene, thinner, commercially available cleaners, or antistatic spray intended for analog records.



Cleaning the disc lens

- After prolonged use, dirt or dust may accumulate at the disc lens. To ensure good playback quality, clean the disc lens with Philips CD Lens Cleaner or any commercially available cleaner. Follow the instructions supplied with the cleaner.

Cleaning the Heads and the Tape Paths

- To ensure good recording and playback quality, clean the heads (A), the capstan(s) (B), and pressure roller(s) (C) after every 50 hours of tape operation.
- Use a cotton swab slightly moistened with cleaning fluid or alcohol.
- You also can clean the heads by playing a cleaning tape once.

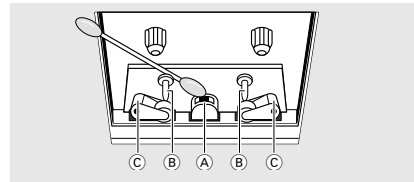

Demagnetizing the heads

- Use a demagnetizing tape available at your dealer.



Specifications

English

AMPLIFIER

Output power	
Total power	500 W total power
	2 x 140 W RMS ⁽¹⁾ / 2 x 110 W FTC ⁽¹⁾
Booster	220 W
Stereo Mode	280 W
Signal-to-noise ratio	≥ 75 dBA (IEC)
Frequency response	50 – 20000 Hz, ± 3 dB
Input sensitivity	
AUX In / CDR/DVD In	500 mV / 1V
Output	
Speakers	≥ 6 Ω
Booster Speakers	≥ 6 Ω
Headphones	32 Ω – 1000 Ω
Line Out	500 mV ±2dB, > 22000 Ω
Digital Out	IEC 958, 44.1 kHz
	(1) (6 Ω, 60 Hz – 12.5 kHz, 10% THD)

CD PLAYER

Number of programmable tracks	40
Frequency response	20 – 20000 Hz
Signal-to-noise ratio	≥ 76 dBA
Channel separation	≥ 79 dB (1 kHz)
Total harmonic distortion	< 0.02% (1 kHz)

TUNER

FM wave range	87.5 – 108 MHz
AM wave range	530 – 1700 kHz
Number of presets	40
Antenna	
FM	300 Ω dipole wire
AM	Loop antenna

TAPE PLAYER

Frequency response	
Normal tape (type I)	80 – 10000 Hz (8 dB)
Signal-to-noise ratio	
Normal tape (type I)	≥ 48 dBA
Wow and flutter	≤ 0.4% DIN

SPEAKERS

Front left/right

System	3-way; Bass reflex system with front firing wOOx
Impedance	6 Ω
wOOx	1 x 6.5" front firing wOOx driver
Woofer	1 x 6.5"
Tweeter	1 x 2"
Polydome Tweeter	1 x 1"
Dimensions (w x h x d)	240 x 350 x 310 (mm)
	9.45 x 13.78 x 12.20 (inch)
Weight	4.2 kg each / 9.24 pounds each

BOOSTER SPEAKERS

System	3-way
Impedance	6 Ω
Woofer	2 x 4"
Tweeter	1 x 2"
Dimensions (w x h x d)	140 x 310 x 310 (mm)
	5.51 x 12.20 x 12.20 (inch)
Weight	4.0 kg each / 8.8 pounds each

GENERAL

Material/finish	Polystyrene/Metal
AC Power	120V / 60 Hz
Power Consumption	
Active	175 W
Standby	25 W
Eco Power Standby	< 1 W
Dimensions (w x h x d)	265 x 310 x 390 (mm)
	10.43 x 12.20 x 15.35 (inch)
Weight (without speakers)	
	9.0 kg / 19.80 pounds

BOOSTER UNIT

Material/finish	Polystyrene/Metal/Wood
AC Power	120V / 60 Hz
Power Consumption	
Active	135 W
Standby	25 W
Dimensions (w x h x d)	140 x 310 x 345 (mm)
	5.51 x 12.20 x 13.58 (inch)
Weight (without speakers)	
	7.0 kg / 15.40 pounds

Specifications and external appearance are subject to change without notice.



Troubleshooting

WARNING

Under no circumstances should you try to repair the system yourself, as this will invalidate the warranty. Do not open the system as there is a risk of electric shock.

If a fault occurs, first check the points listed below before taking the system for repair. If you are unable to remedy a problem by following these hints, consult your dealer or service center.

Problem	Solution
CD OPERATION	
"NO DISC" is displayed.	<ul style="list-style-type: none"> – Insert a disc. – Check if the disc is inserted upside down. – Wait until the moisture condensation at the lens has cleared. – Replace or clean the disc, see "Maintenance".
"DISC NOT FINALIZED" is displayed.	<ul style="list-style-type: none"> – Use a finalized CD-R(W) or CD-R.
RADIO RECEPTION	
Radio reception is poor.	<ul style="list-style-type: none"> – If the signal is too weak, adjust the antenna or connect an external antenna for better reception. – Increase the distance between the Mini HiFi System and your TV or VCR.
TAPE OPERATION/RECORDING	
Recording or playback cannot be made.	<ul style="list-style-type: none"> – Clean deck parts, see "Maintenance". – Use only NORMAL (IEC I) tape. – Apply a piece of adhesive tape over the missing tab space.
The tape deck door cannot open.	<ul style="list-style-type: none"> – Remove and reconnect the AC power plug and switch on the system again.



Troubleshooting

GENERAL

The system does not react when buttons are pressed.	<ul style="list-style-type: none"> – Remove and reconnect the AC power plug and switch on the system again.
Sound cannot be heard or is of poor quality.	<ul style="list-style-type: none"> – Adjust the volume. – Disconnect the headphones. – Check that the speakers are connected correctly. – Check if the stripped speaker wire is clamped.
The left and right sound outputs are reversed.	<ul style="list-style-type: none"> – Check the speaker connections and location.
The remote control does not function properly.	<ul style="list-style-type: none"> – Select the source (CD or TUNER, for example) before pressing the function button (▶, ◀, ▶). – Reduce the distance between the remote control and the system. – Insert the batteries with their polarities (+/- signs) aligned as indicated. – Replace the batteries. – Point the remote control in the direction of the system's IR sensor.
The timer is not working.	<ul style="list-style-type: none"> – Set the clock correctly. – Press TIMER ON/OFF to switch on the timer. – If recording is in progress, stop recording.
Not all lighted buttons are showing light.	<ul style="list-style-type: none"> – Press DISPLAY to select NORMAL or MODE 1 display mode.
The Clock/Timer setting is erased.	<ul style="list-style-type: none"> – Power has been interrupted or the power cord has been disconnected. Reset the clock/timer.
The system displays features automatically and buttons start flashing.	<ul style="list-style-type: none"> – Press and hold DEMO STOP ■ on the system to switch off the demonstration.





LIMITED WARRANTY

AUDIO SYSTEM

One Year Free Labor

One Year Free Service on Parts

This product must be carried in for repair.

WHO IS COVERED?

You must have proof of purchase to receive warranty service. A sales receipt or other document showing that you purchased the product is considered proof of purchase.

WHAT IS COVERED?

Warranty coverage begins the day you buy your product. For one year thereafter, all parts will be repaired or replaced, and labor is free. After one year from the day of purchase, you pay for the replacement or repair of all parts, and for all labor charges.

All parts, including repaired and replaced parts, are covered only for the original warranty period. When the warranty on the product expires, the warranty on all replaced and repaired parts also expires.

WHAT IS EXCLUDED?

Your warranty does not cover:

- labor charges for installation or setup of the product, adjustment of customer controls on the product, and installation or repair of antenna systems outside of the product.
- product repair and/or part replacement because of misuse, accident, unauthorized repair or other cause not within the control of Philips Consumer Electronics Company.
- reception problems caused by signal conditions or cable or antenna systems outside the unit.
- a product that requires modification or adaptation to enable it to operate in any country other than the country for which it was designed, manufactured, approved and/or authorized, or repair of products damaged by these modifications.
- incidental or consequential damages resulting from the product. (Some states do not allow the exclusion of incidental or consequential damages, so the above exclusion may not apply to you. This includes, but is not limited to, prerecorded material, whether copyrighted or not copyrighted.)
- a product that is used for commercial or institutional purposes.

WHERE IS SERVICE AVAILABLE?

Warranty service is available in all countries where the product is officially distributed by Philips Consumer Electronics Company. In countries where Philips Consumer Electronics Company does not distribute the product, the local Philips service organization will attempt to provide service (although there may be a delay if the appropriate spare parts and technical manual(s) are not readily available).

MAKE SURE YOU KEEP...

Please keep your sales receipt or other document showing proof of purchase. Attach it to this owner's manual and keep both nearby. Also keep the original box and packing material in case you need to return your product.

BEFORE REQUESTING SERVICE...

Please check your owner's manual before requesting service. Adjustments of the controls discussed there may save you a service call.

TO GET WARRANTY SERVICE IN U.S.A., PUERTO RICO OR U.S. VIRGIN ISLANDS...

Take the product to a Philips factory service center (see enclosed list) or authorized service center for repair. When the product has been repaired, you must pick up the unit at the center. Centers may keep defective parts.

(In U.S.A., Puerto Rico and U.S. Virgin Islands, all implied warranties, including implied warranties of merchantability and fitness for a particular purpose, are limited in duration to the duration of this express warranty. But, because some states do not allow limitations on how long an implied warranty may last, this limitation may not apply to you.)

TO GET WARRANTY SERVICE IN CANADA...

Please contact Philips at:

1-800-661-6162 (French Speaking)

1-800-363 7278 (English Speaking)

(In Canada, this warranty is given in lieu of all other warranties. No other warranties are expressed or implied, including any implied warranties of merchantability or fitness for a particular purpose. Philips is not liable under any circumstances for any direct, indirect, special, incidental or consequential damages, howsoever incurred, even if notified of the possibility of such damages.)

REMEMBER...

Please record the model and serial numbers found on the product below. Also, please fill out and mail your warranty registration card promptly. It will be easier for us to notify you if necessary.

MODEL # _____

SERIAL # _____

This warranty gives you specific legal rights. You may have other rights which vary from state/province to state/province.

Philips Service Solutions Group, P.O. Box 2976, Longview, Texas 75606, USA, (903) 242-4800

EL4965E006 / MAC 4110 / 12-98